



Regenwasser-Erdtank-Carat -S- 2700 I
 Rainwater underground tank Carat -S- 2700 I
 mit / with Maxi-Dom

Artikel-Nr.
 Item no.

372024

Dom-Maxi 371040

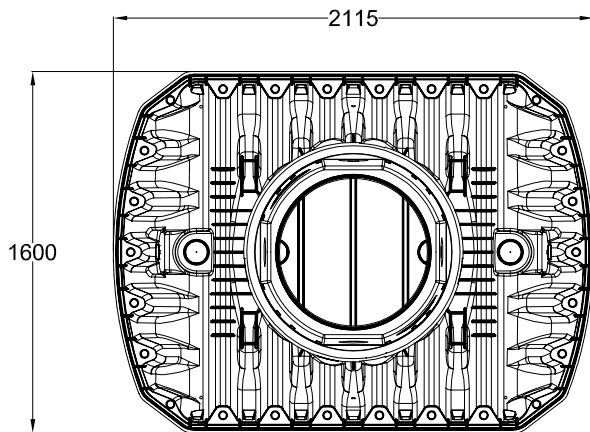
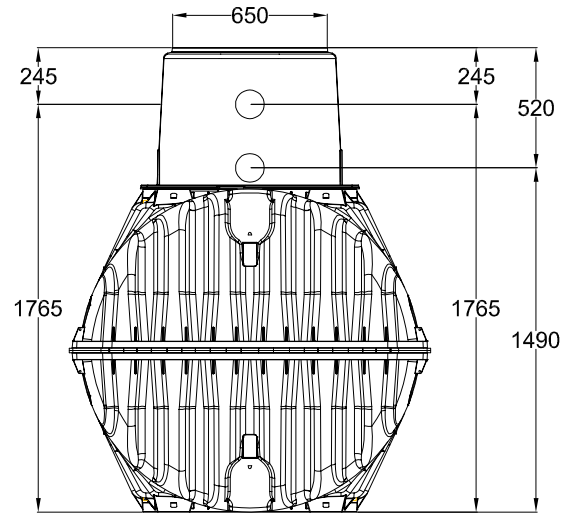
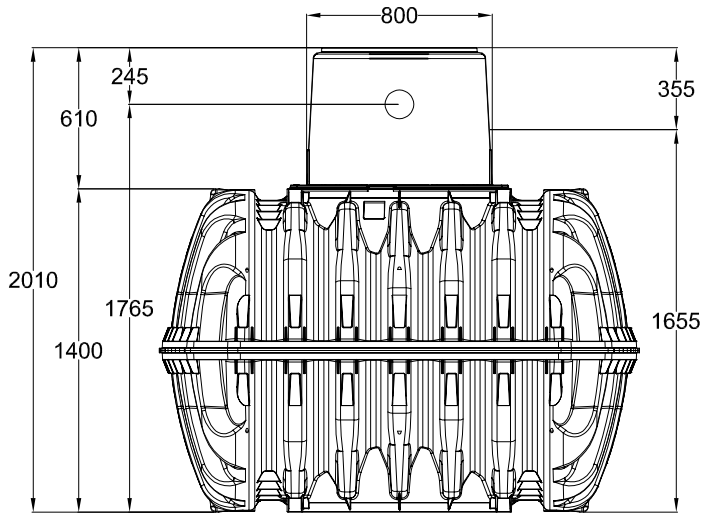

alle Maße +/- 3 % Toleranz
 all dimensions +/- 3% tolerance

Otto Graf GmbH
 Kunststoffzeugnisse
 79331 Teningen

Carl-Zeiss-Str. 2-6
 Telefon 07641/589-0
 Telefax 07641/589-50
 Email: info@graf-online.de
 www.graf-online.de

Gewicht/weight 120 kg

Datum/date

Ausgabe/edition 11/09

Name/name

Blatt/page 1 von 1